

**USER
MANUAL**

pUQ[®]
PREP

MODEL

NAVIGATOR

1-210-0555-1



⚠ WARNING

For more information and more languages, see the extended manual online about safe installation and operation.

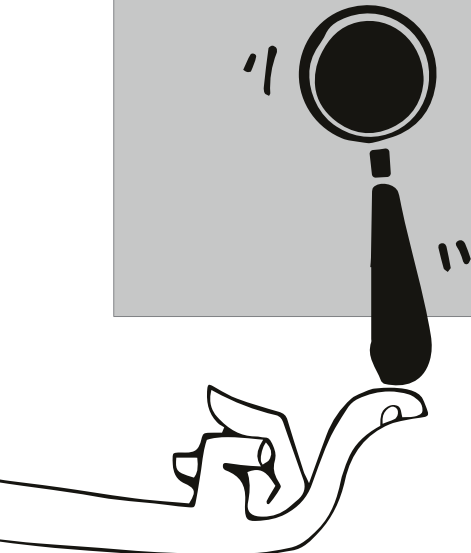

EN	User manual	11
KO	사용자 설명서	38
ES	Manual de usuario	80

EN Original manual

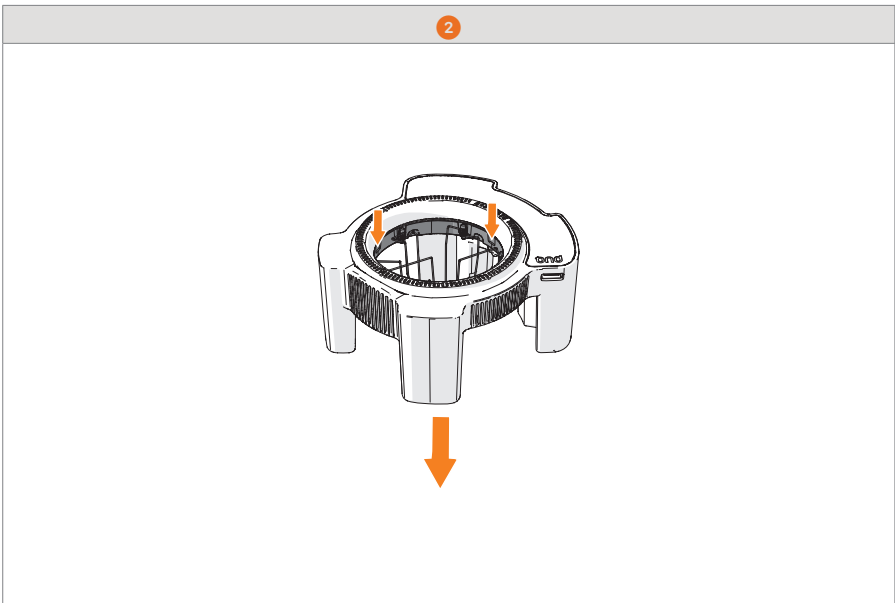
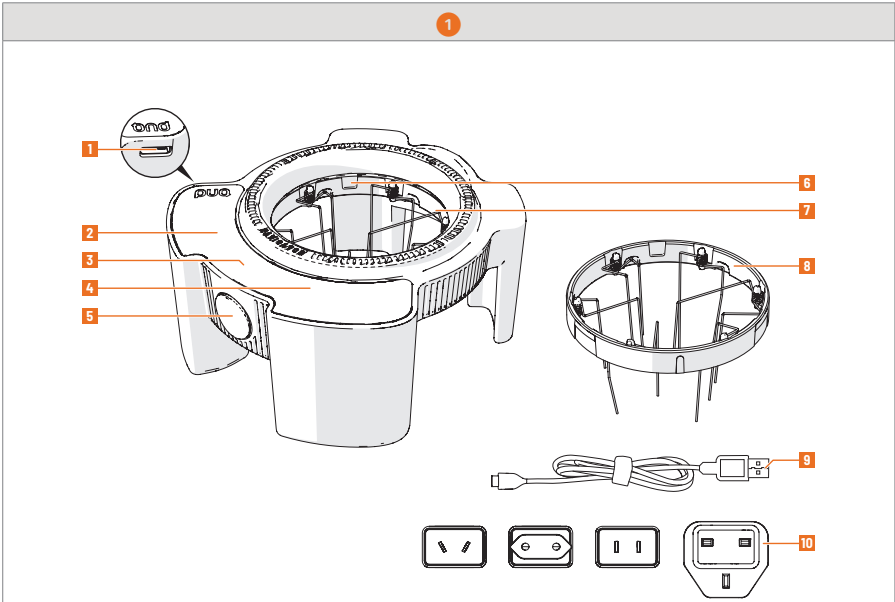

3

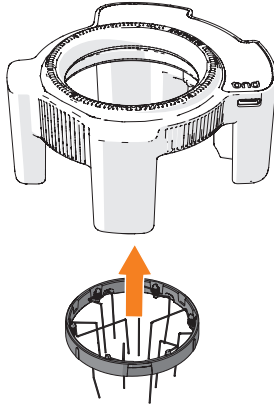

4

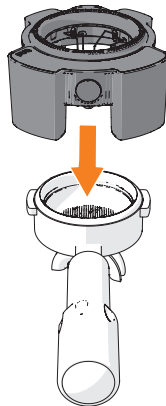

TABLE OF CONTENT

1	Safety	6
1.1	Safety instructions	6
1.2	Personnel requirements	7
1.3	Explanation of the symbols on the product and packaging	7
2	Introduction	8
2.1	Used symbols in this manual	8
2.2	Warranty	8
2.3	Disclaimer	9
3	Product description	9
3.1	Intended use	9
3.2	Specifications	9
3.3	Main parts	9
4	Installation	10
4.1	Preparation	10
4.2	Charging the PUQ Prep Navigator	10
4.3	Changing the needle ring	10
4.4	Switching on the PUQ Prep Navigator	11
5	Operation	11
5.1	Preparation	11
5.2	Adjusting the distribution profile	11
5.3	Using the PUQ Prep Navigator	11
5.4	Adjusting other settings	12
5.5	Switching off the PUQ Prep Navigator	12
6	Maintenance	13
6.1	Preparation	13
6.2	Cleaning	13
6.3	Storing	13
6.4	Maintaining	13
7	Troubleshooting	14
8	Disposal	14

DEAR COFFEE ENTHUSIAST,

Welcome to the PUQ family and congratulations on your new PUQ Prep Navigator! Thank you for placing your trust in our product, we're excited to help you elevate your coffee game.

The PUQ Prep Navigator is an automatic coffee distributor designed for use with a portafilter, built by a team who shares your passion for exceptional coffee and smart, elegant technology. Our specialists have poured all their expertise and dedication into developing the ultimate tool for standardizing the distribution of coffee in your routine, an essential step for achieving that perfect cup.

We encourage you to take the time to read this manual thoroughly, ensuring you unlock the full potential of your Navigator. Store it somewhere safe, and if you have any questions, don't hesitate to reach out to your authorized dealer or contact us directly.

We're here to help.

With the Navigator in your routine, you'll experience smoother workflows, giving you more time to focus on exploring flavors, experimenting with techniques, and creating memorable coffee moments.

Here's to mastering your craft and enjoying every step of the journey!

Greetings from Amsterdam,

The PUQ Team of Barista Technology B.V.

1 SAFETY

1.1 Safety instructions

WARNING

- Ensure you have fully read and understood the instructions in this document before you install or use the PUQ Prep Navigator. Keep this document for future reference.
- Only use the PUQ Prep Navigator as described in this document.
- This appliance can be used by children aged from 8 years and above and persons with reduced physical, sensory or mental capabilities or lack of experience and knowledge if they have been given supervision or instruction concerning use of the appliance in a safe way and understand the hazards involved.
- Never let children play with the PUQ Prep Navigator. Not doing so may result in the PUQ Prep Navigator getting damaged.
- Cleaning and user maintenance shall not be made by children without supervision.
- Never immerse cables, or the PUQ Prep Navigator itself into water or other liquids to avoid electric shock, or injury.
- Never use the PUQ Prep Navigator if the PUQ Prep Navigator is damaged. Any required repairs may only be conducted by authorized service personnel. For this reason, please contact a customer

service repair facility or your distributor. Using the PUQ Prep Navigator if the PUQ Prep Navigator is damaged may result in electric shock, or injury.

CAUTION

- Never make any modifications or alterations to the PUQ Prep Navigator. The manufacturer holds no liability for damages resulting from failure to observe these instructions.
- Never drop the PUQ Prep Navigator and avoid bumping. Not doing so results in the PUQ Prep Navigator getting damaged.
- Never operate the PUQ Prep Navigator in moist or wet conditions.
- Never clean the PUQ Prep Navigator with a jet of water or a steam cleaner.
- Always switch off the PUQ Prep Navigator before performing maintenance or cleaning on the PUQ Prep Navigator to avoid electric shock, or injury.
- Always use the supplied MKA-0502000 adapter to charge the PUQ Prep Navigator.
- Always use an external supply with the following specifications: 5 V, 5 W (max.).
- Never use a laptop adapter to charge the PUQ Prep Navigator.
- Never expose the PUQ Prep Navigator to excessive temperatures.











- The PUQ Prep Navigator contains batteries that are non-replaceable. Always dispose of the PUQ Prep Navigator properly when the battery is at end of life.



1.2 Personnel requirements

The user of this PUQ Prep Navigator does not need special requirements. Ensure you have fully read and understood the instructions in this document before you install or use the PUQ Prep Navigator. Keep this document for future reference.

1.3 Explanation of the symbols on the product and packaging

	<p>Electronic equipment needs to bear the CE mark in order to be marketed in the EU. CE marking shows that a product is assessed before being placed on the market and that it meets EU safety, health and environmental protection requirements. CE marking is also sometimes accepted as a means of compliance with type-approval requirements; for example, electronic components that require type-approval and also CE marking for electromagnetic compatibility (EMC) or low-voltage equipment.</p>
---	---

	<p>Indication that the PUQ Prep Navigator is an Electrical class I product, with provided means for the connection of conductive parts (which are not live parts) to the protective (earthing) conductor in the fixed wiring in such a way that these parts cannot become live in the event of a failure of the basic insulation.</p>
	<p>Indication that the PUQ Prep Navigator is fragile.</p>
	<p>Indication that the PUQ Prep Navigator must be kept dry.</p>
	<p>Indication that the PUQ Prep Navigator must be handled with care.</p>
	<p>Read the manual before use.</p>
	<p>Indication to explain that the PUQ Prep Navigator is cETLus Intertek certified.</p>
	<p>Indication to explain that the PUQ Prep Navigator is ETL sanitation certified.</p>
	<p>Indication to explain that the PUQ Prep Navigator is PSE certified.</p>
	<p>Indication to explain that the PUQ Prep Navigator is KC certified.</p>
	<p>Indication that the PUQ Prep Navigator has a detachable power supply part.</p>

	<p>Indication to explain that the PUQ Prep Navigator needs to be collected separately when disposed. Do not throw in the trash bin.</p>
	<p>Indication to explain that the packaging can be recycled.</p>

2 INTRODUCTION

2.1 Used symbols in this manual

WARNING

WARNING indicates a hazardous situation which, if not avoided, could result in death or serious injury.

CAUTION

CAUTION indicates a hazardous situation which, if not avoided, could result in minor or moderate injury. CAUTION is also used to address practices not related to physical injury.

NOTICE

NOTICE indicates useful information.

2.2 Warranty

- The warranty period is 2 years from the date of purchase. Refer to the chapter 'Specifications' on the amount of charging cycles covered by the warranty.
- The warranty covers all damages that can be attributed to inferior materials or

defective workmanship. The corresponding PUQ Prep Navigator will be repaired or replaced free-of-charge, with the exception of transport or freight charges. Proper transport is the responsibility of the customer, so please try to avoid damages during a product return by correctly packing the PUQ Prep Navigator. Use the original packaging to return the PUQ Prep Navigator.

- This warranty does not cover damages which have occurred through:
 - improper usage,
 - improper maintenance,
 - lack of servicing,
 - usage for purposes other than those intended,
 - incorrect installation,
 - breakage,
 - natural wear or for reasons beyond our sphere of influence.
- In order to maintain the warranty, only original spare parts and accessory parts may be used.
- The manufacturer is in no way liable for consecutive or secondary damages.
- The warranty does not cover costs resulting from repairs conducted by non-authorized personnel.

2.3 Disclaimer

Copyright © 2024 Barista Technology B.V. All rights reserved. No part of this publication may be reproduced or transmitted in any form or by any means without the prior written permission of Barista Technology B.V. The information in this publication is proprietary to Barista Technology B.V.

3 PRODUCT DESCRIPTION

3.1 Intended use

The PUQ Prep Navigator is intended as an automatic coffee distributor for the ground coffee in a portafilter.

Grounded coffee can be distributed with adjustable settings.

The PUQ Prep Navigator is only intended to be used on portafilters (group handles) with a larger diameter than 57.3 mm / 2.6 inch. The PUQ Prep Navigator is intended to be used for commercial applications, for example in kitchens of restaurants, canteens, hospitals and in commercial enterprises such as bakeries, butcheries, etc., but not for continuous mass production of food.

The PUQ Prep Navigator is intended for indoor use only.

Any modification of the PUQ Prep Navigator may have consequences for safety, warranty and proper functioning.

3.2 Specifications

Model	PUQ Prep Navigator
Charging voltage	5 VDC, 1 A (max.)
Nominal battery voltage	3.7 V, voltage range 3.5 – 4.2 V
Battery	Rechargeable lithium-ion battery, 3.7 V, 6.29 Wh, 1700 mAh
Charging cable	USB-A to USB-C
Power	5 W (max.)
Dimensions	97 x 99 x 49 mm 3.8 x 3.9 x 1.9 inch
Weight	0.42 kg 0.93 lbs
Distribution profiles	3 (speedy, standard, precise)
Operating temperature	0 °C – 70 °C 32 °F – 158 °F
Charging temperature	10 °C – 30 °C 50 °F – 86 °F
Storing temperature	-40 °C – 85 °C -40 °F – 185 °F
Warranty	2 years
Charging cycles within the warranty	350 cycles

3.3 Main parts

See **1** for an overview of the main parts of the Navigator.

1. USB-C port
2. Left touch button
3. DOT LED display
4. Right touch button
5. Main push button

6. Notch for removing needle ring
7. White or black needle ring (19 grams / 0.67 ounce or more)
8. Anthracite needle ring (19 grams / 0.67 ounce or less)
9. USB-A to USB-C cable
10. USB charger

4 INSTALLATION

4.1 Preparation

4.1.1 Checking the contents

Check that all parts are present and that no damage is visible on the parts. If parts are missing or damaged, contact your dealer or your authorised customer service centre.

1 ×	PUQ Prep Navigator
1 ×	White or black needle ring (installed in the PUQ Prep Navigator)
1 ×	Anthracite needle ring
1 ×	USB-A to USB-C cable
1 ×	USB charger
1 ×	Quick start guide

4.1.2 Tools and materials

Required tools and materials

- Flat head screwdriver (optional)

4.2 Charging the PUQ Prep Navigator

Charge the PUQ Prep Navigator before first use and when the battery is down to 25 percent. The display shows LOW if the battery is almost empty.

1. Plug the USB-A to USB-C cable into the USB-C port.
2. Plug the other end of the USB-A to USB-C cable into the supplied adapter.
3. Plug the USB adapter into a socket and/ or (wall) outlet.

The display shows the battery level.

NOTICE

- The battery of the PUQ Prep Navigator is charged to a maximum of 30 percent when delivered.
- The battery of the PUQ Prep Navigator can be charged up to 99 percent.
- The PUQ Prep Navigator cannot be used during charging.

4.3 Changing the needle ring

1. Check if the portafilter (group handle) can hold more or less than 19 grams / 0.67 ounce of coffee.

If the portafilter can hold 19 grams / 0.67 ounce or more of coffee, the installed needle ring is correct for your portafilter.

If the portafilter can hold less than 19 grams / 0.67 ounce of coffee, follow the next steps.

2. Remove the white or black needle ring with your thumbs or a flat head screwdriver. **2**
3. Insert and fasten the anthracite needle ring. **3**

4.4 Switching on the PUQ Prep Navigator

1. Press and hold the **main push button** for 1 second to switch on the PUQ Prep Navigator.

5 OPERATION

5.1 Preparation

5.1.1 Tools and materials

Required tools and materials

- Portafilter (group handle) with grounded coffee

5.2 Adjusting the distribution profile

1. Press and hold the **left touch button** or **right touch button** for 1 second.

The PUQ Prep Navigator vibrates and the distribution profile blinks on the display.

2. Press the **left touch button** or **right touch button** to scroll through the distribution profiles.
3. Choose between the following distribution profiles:

Code	Setting	Explanation
SPD	SPEEDY	Fast distributing speed 1.5 seconds
STD	STANDARD	Default distributing speed 3 seconds
PRE	PRECISE	Slow distributing speed 5 seconds

4. Press the **main push button** to confirm the setting.
5. Press the **left touch button** or **right touch button** to set a delay time interval.

The delay time interval can be set between 0 and 10 seconds with an interval of 0.5 seconds.

6. Press the **main push button** to confirm the delay time interval.

The display shows the selected distribution profile.

5.3 Using the PUQ Prep Navigator

1. Place the PUQ Prep Navigator on the portafilter (group handle). 
2. Press the **main push button** to start distributing the ground coffee.

NOTICE

- The PUQ Prep Navigator switches to sleep mode automatically after 30 seconds.
- The PUQ Prep Navigator switches off

automatically after 5 minutes.

- Shake the product or press the main push button to wake up the PUQ Prep Navigator.

5.4 Adjusting other settings

1. Press and hold the **left touch button** or **right touch button** for 1 second.

The PUQ Prep Navigator vibrates and the distribution profile blinks on the display.

2. Press and hold the **main push button** for 3 seconds. The **DOT LED display** shows DIS.
3. Press the **left touch button** or **right touch button** to scroll through the other settings.
4. Choose between the following settings:

Code	Setting	Explanation
DIS	Display intensity	Press the left touch button and the right touch button to change the display intensity. Default is 75 percent.
BUR	Burn-in/run-in test	Test the motor of the PUQ Prep Navigator.
FAC	Factory test	Perform an initial factory test.

VER	Version number	Check the version number of the PUQ Prep Navigator.
CNT	Cycle counter	Check the amount of user cycles. Multiply the number on the display by 500.
EXI	Exit	Exit the other settings. Exiting via EXI saves the changed DIS settings.

5. Press the **main push button** to confirm/ enter the setting.

The display intensity can be set between 25 and 100 percent with steps of 25 percent.

6. Press the **main push button** to confirm exiting the menu when the display shows EXI. The changed DIS settings are saved.

NOTICE

The PUQ Prep Navigator exits the other settings automatically after 10 seconds of inactivity or movements. Changed settings are not saved.

5.5 Switching off the PUQ Prep Navigator

1. Press and hold the **main push button** for 3 seconds to switch off the PUQ Prep Navigator.

6 MAINTENANCE

6.1 Preparation

6.1.1 Tools and materials

Required tools and materials

- Brush
- Dry cloth

6.2 Cleaning

1. Remove the needle ring with your thumbs or a flat head screwdriver.
2. Clean the needle ring.
3. Reinsert the needle ring.

Refer to the table for an overview of the cleaning intervals.

Part	Cleaning method	Cleaning interval
Needle ring	Brush	Weekly
Housing	Dry cloth	Monthly

NOTICE

Make sure to clean the parts of the PUQ Prep following the cleaning intervals. Not doing so may result in parts of the PUQ Prep Navigator getting damaged.

6.3 Storing

Store the PUQ Prep Navigator indoors in a dry and secure location, out of reach of children.

6.4 Maintaining

6.4.1 Servicing

Any required repairs may only be conducted by authorized specialist personnel. For this reason, please contact a customer service repair facility or your dealer. Refer to the safety instructions in chapter 'Safety instructions'.

It is advised to conduct all maintenance and repairs by a customer service centre or your distributor.

6.4.2 Ordering spare parts

Spare parts can be ordered from your customer service centre or your local distributor.

To ensure quick and correct processing of your order, the following information is essential:

- Serial number
- Description of the part to be replaced.
Use the same name as the part is specified as in chapter 'Main parts'.

7 TROUBLESHOOTING

Problem	Cause(s)	Solution(s)
The PUQ Prep Navigator does not switch on, the display does not work.	The battery of the PUQ Prep Navigator is empty.	Charge the PUQ Prep Navigator.
The display shows three dots and switches off.	The battery of the PUQ Prep Navigator is empty.	Charge the PUQ Prep Navigator.
The display shows LOW.	The battery of the PUQ Prep Navigator is empty.	Charge the PUQ Prep Navigator.
The drive unit makes weird noises.	The drive unit (e-motor and gears) is worn out.	Contact the distributor to replace the drive unit. Specify the amount of battery charging cycles the drive unit has had.
Ground coffee is not distributed properly.	The wrong needle ring is used.	Change the needle ring to the correct size.

In case of other malfunctions or continued faults, please contact your dealer or your authorised customer service centre.

8 DISPOSAL



This symbol indicates that the PUQ Prep Navigator should not be thrown away with other household waste throughout the EU. To prevent possible harm to the environment or human health by uncontrolled waste disposal, you are responsible for recycling it so that it can promote the sustainable reuse of raw materials. To return your used PUQ Prep Navigator, you can use the regular return and collection systems or contact the distributor where the PUQ Prep Navigator was purchased. They can recycle the PUQ Prep Navigator for the environment.

Dispose of the PUQ Prep Navigator following the locally applicable regulations or return the PUQ Prep Navigator to your distributor. Use the original packaging to return the PUQ Prep Navigator.